

front view
Ansicht von vorn

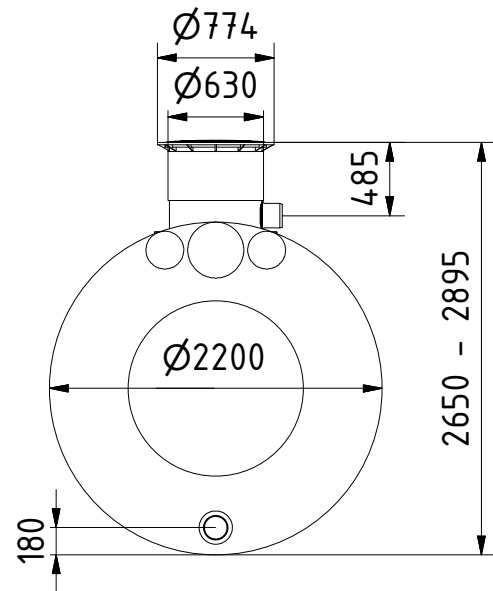

retention throttle DN 150
Retentionsdrossel

inflow
Zulauf DN150

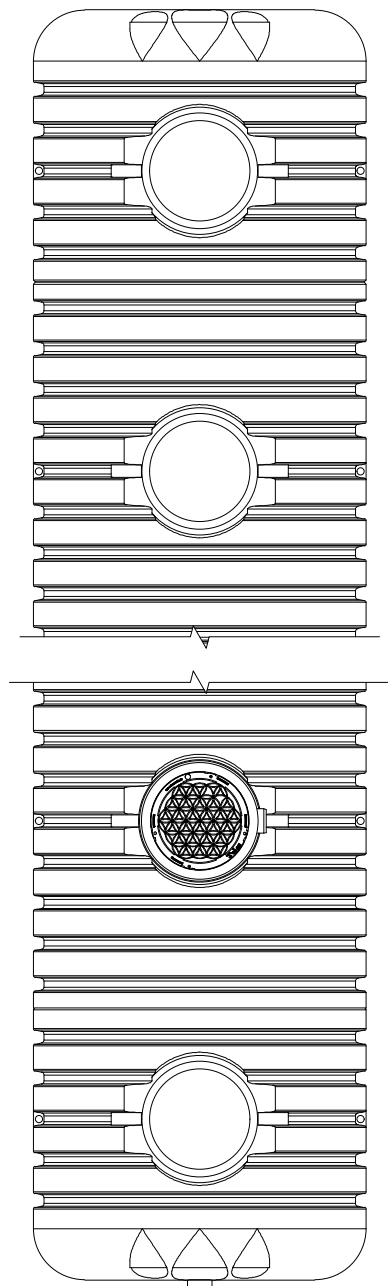
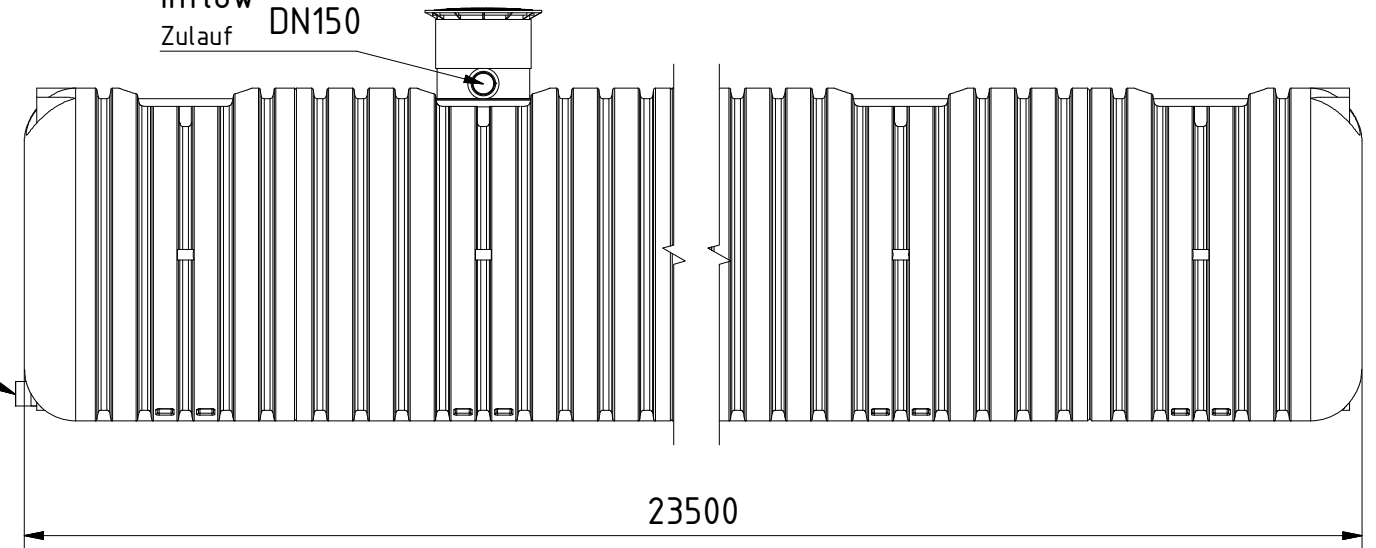

top view
Ansicht von oben



 <p>GreenLife GmbH Sacktannen 1a 19057 Schwerin Tel. +49 385 77337-0 Fax. +49 385 77337-33 info@greenlife.info</p>	<p>all dimensions in mm alle Angaben in mm</p>	<p>scale Maßstab 1:50</p>	<p>weight Masse</p>
	<p>creator date A Ackermann 14.06.2018</p>	<p>material Material</p>	
<p>All tank-connections are displayed as example. They are not pre-installed and have to be adapted in place. Alle Tankverbindungen sind beispielhaft dargestellt. Sie sind nicht vorinstalliert und müssen vor Ort angepasst werden.</p>			
<p>* Additional equipment required Technical developments and changes in individual items, as well as errors, misprint and price alterations reserved. Photos and drawings are nonbinding. Depending on the technology, minor dimensions, weight and color variations may occur. optionales Zubehör erforderlich Technische Weiterentwicklungen und Änderungen der einzelnen Artikel, sowie Irrtümer, Druckfehler und Preisänderungen vorbehalten. Fotos und Zeichnungen sind unverbindlich. Technologisch bedingt können geringfügige Maß-, Gewichts- und Farbabweichungen auftreten.</p>			
<p>Retentionstank GRT 82.2</p>			<p>art nr. Artikel Nr. G0003694</p>
			<p>sheet Blatt 1 / 1</p>